

# DALLAS 21

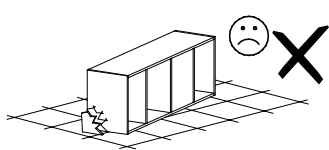

Narzędzia potrzebne do montażu

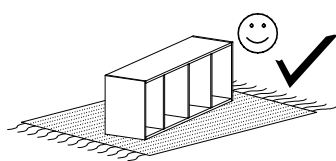
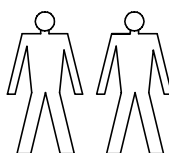
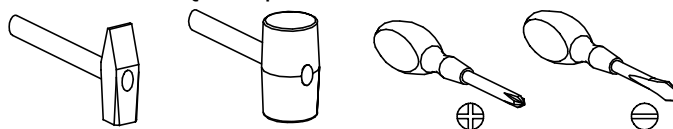

## UWAGA !!!

MONTOWANIE USZKODZONYCH  
ELEMENTÓW POWODUJE UTRATĘ  
GWARANCJI

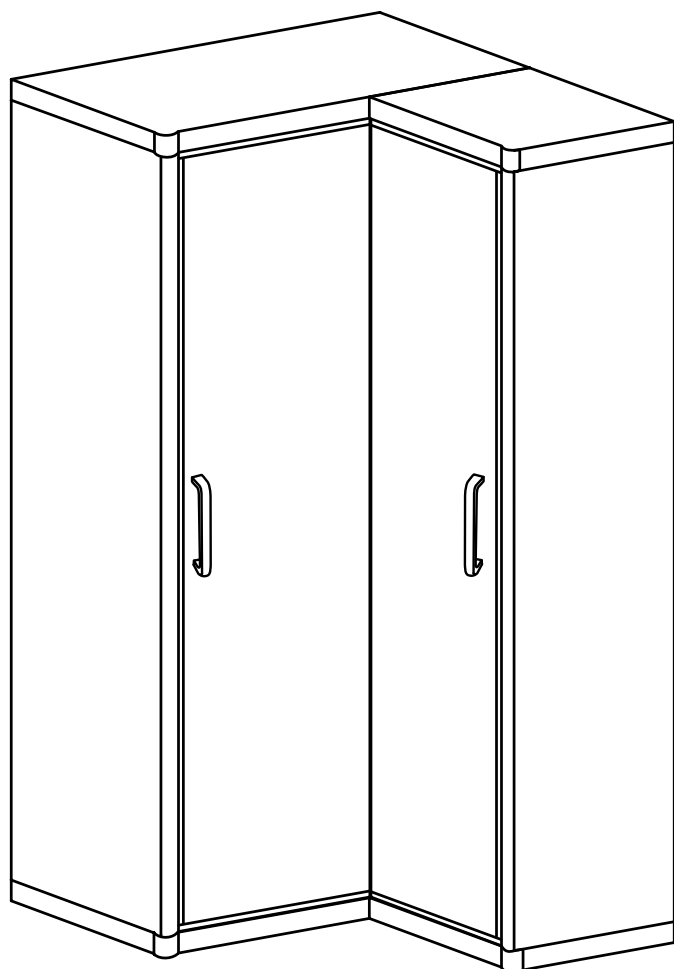

Nr	D[mm]	S[mm]	G[mm]	Ilość
1	553	450	48	1
2	1000	590	48	1
3	1000	590	48	1
4	553	450	48	1
5	1810	423	16	1
6	1810	562	16	1
7	1810	100	32	1
8	1810	100	32	1
9	1810	435	16	1
10	1810	400	16	1
11	966	400	16	1
12	548	380	16	1
13	548	380	16	4
14	1835	990	2,5	1
15	1835	840	2,5	1
16	1780	463	16	1
17	1780	463	16	1

W przypadku reklamacji proszę podać numer pakowacza znajdujący się na kartonie.

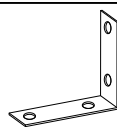

**Y - 2 St.**

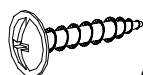

**Q - 4 St.**  
3,5x16 mm

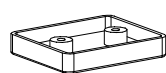

**A - 7 St.**

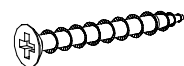

**R - 14 St.**  
3x25 mm



**M - 1 St.**

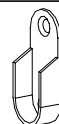

**T - 2 St.**

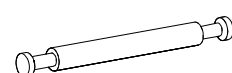

**F - 6 St.**



**O - 24 St.**  
3x16 mm



**N - 4 St.**  
4x30 mm



**U - 2 St.**



**G - 16 St.**  
3,5x16 mm

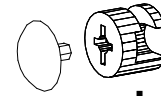

**L - 38 St.**

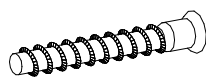

**W - 2 St.**



**E - 100 St.**

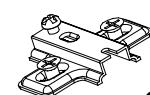

**C - 8 St.**

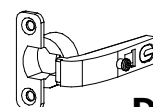

**D - 4 St.**



**S - 1 St.**



**P - 20 St.**



**B - 24 St.**

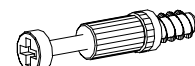

**K - 26 St.**

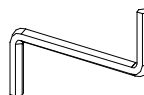

**Z - 1 St.**

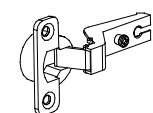

**J - 4 St.**

I

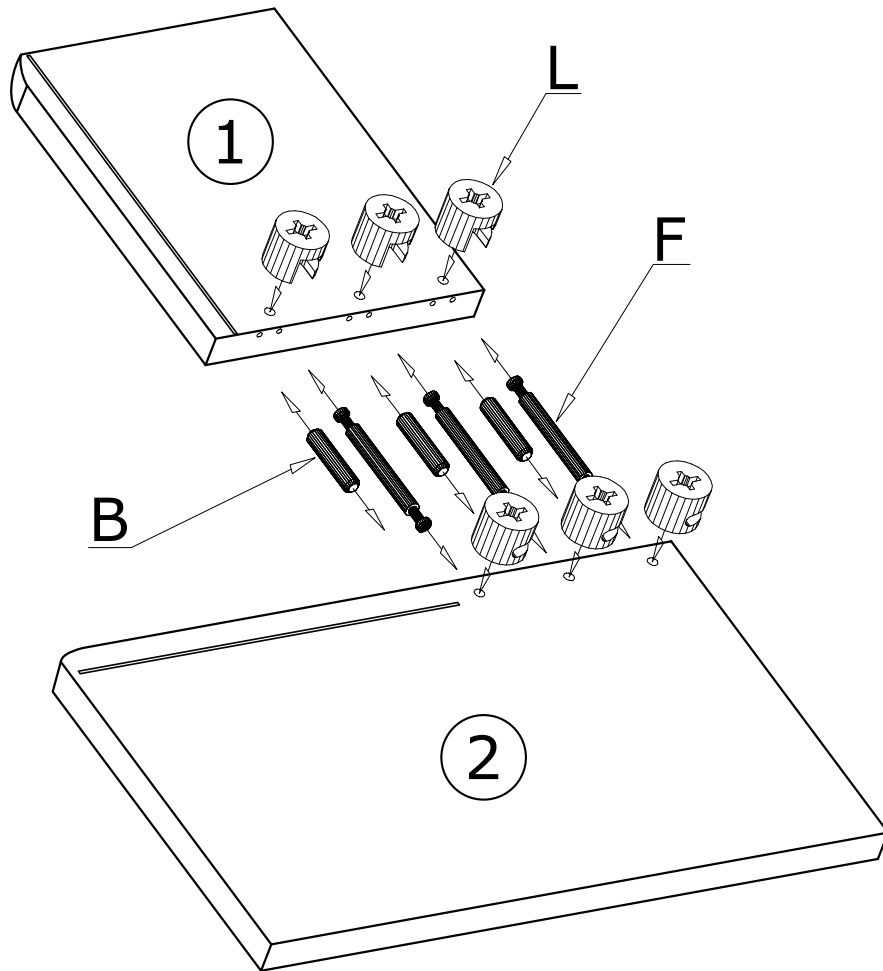

II

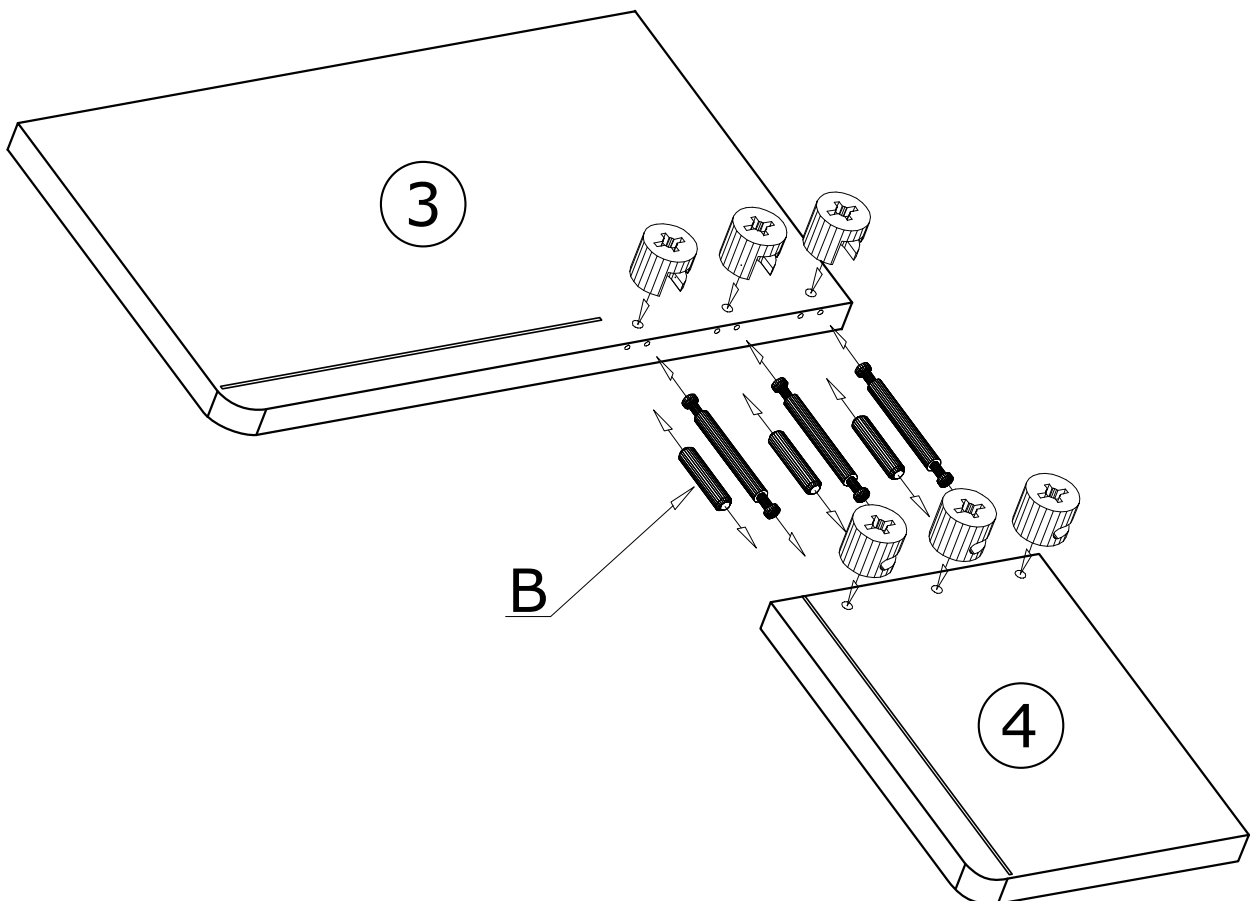

III

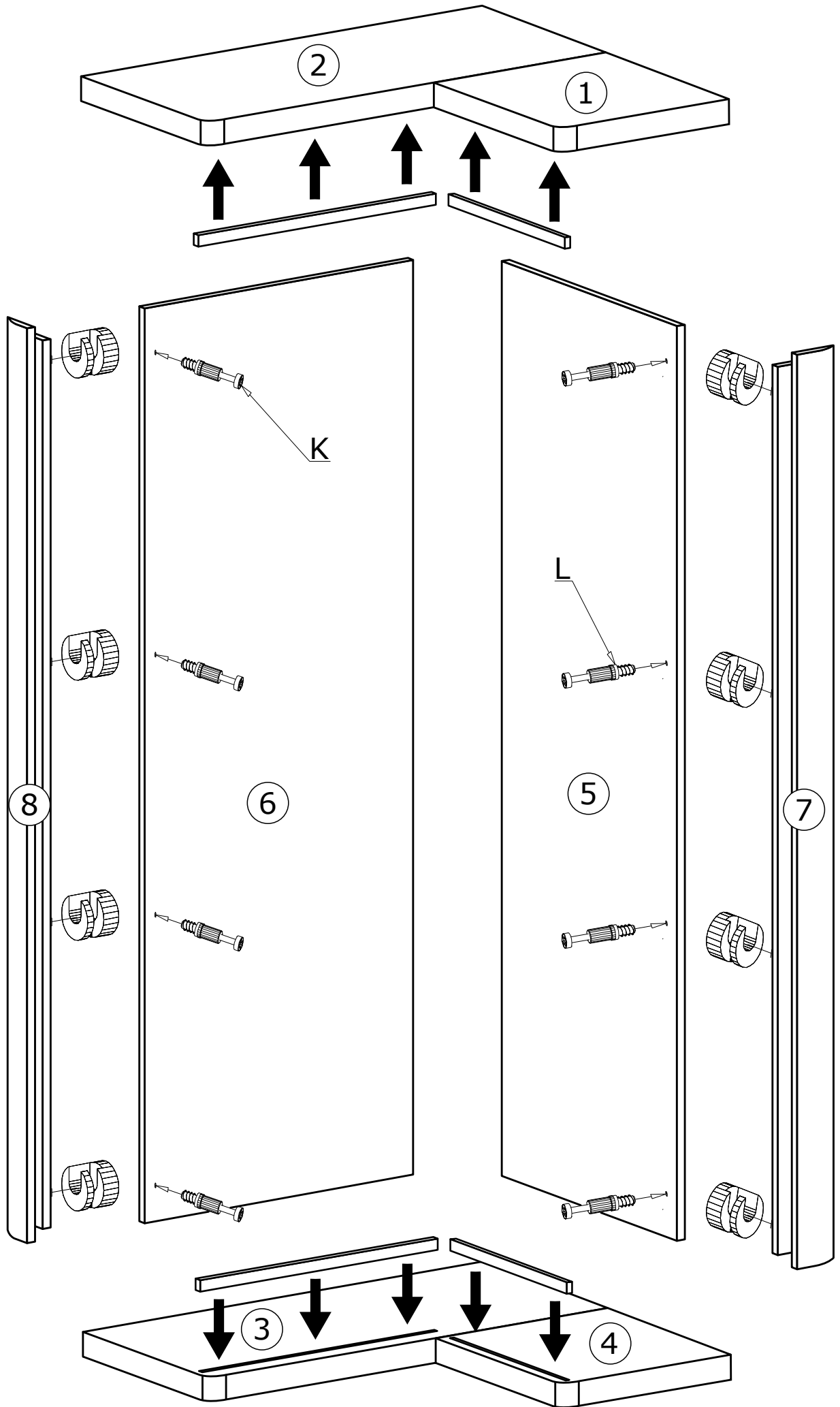

IV

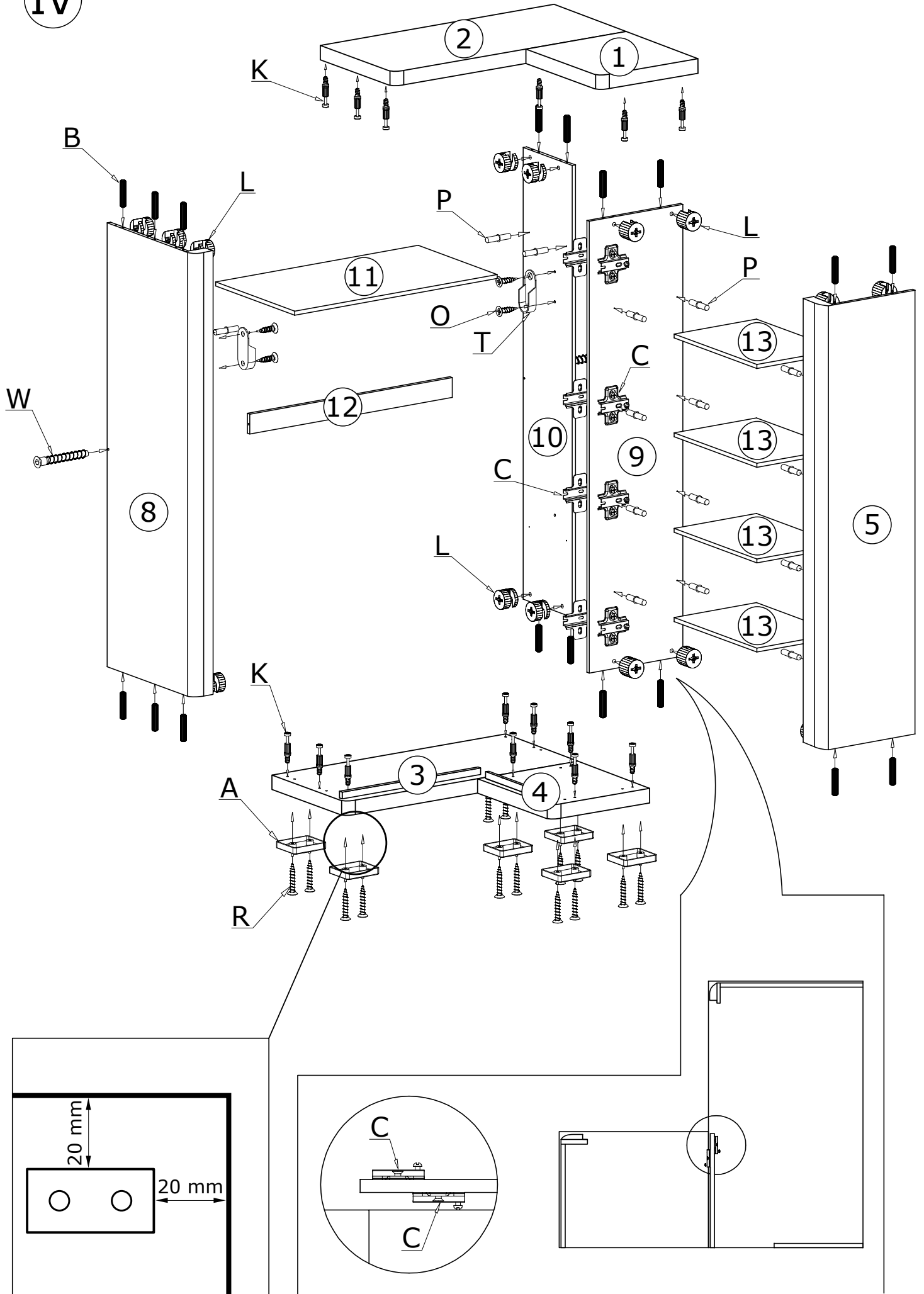

V

100X 

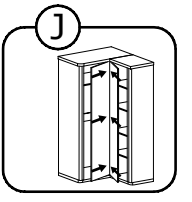
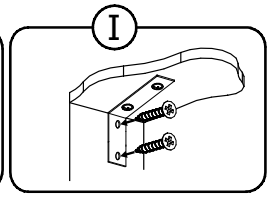
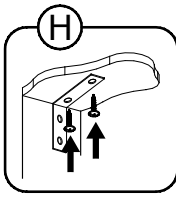
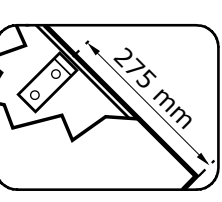
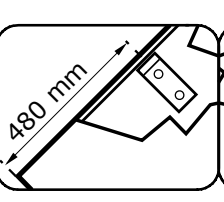
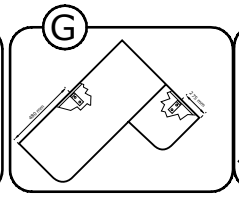
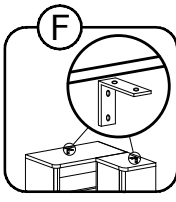
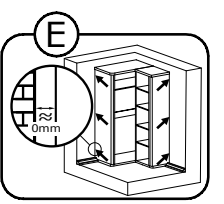
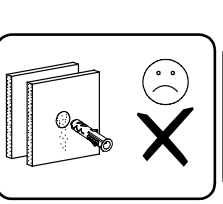
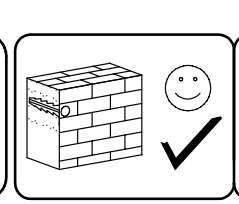
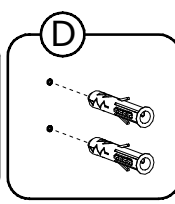
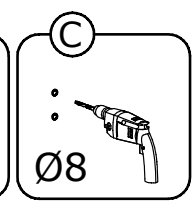
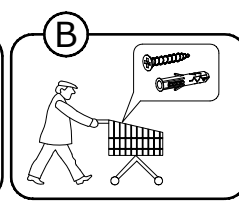
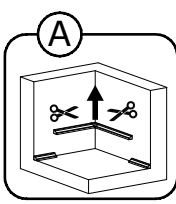
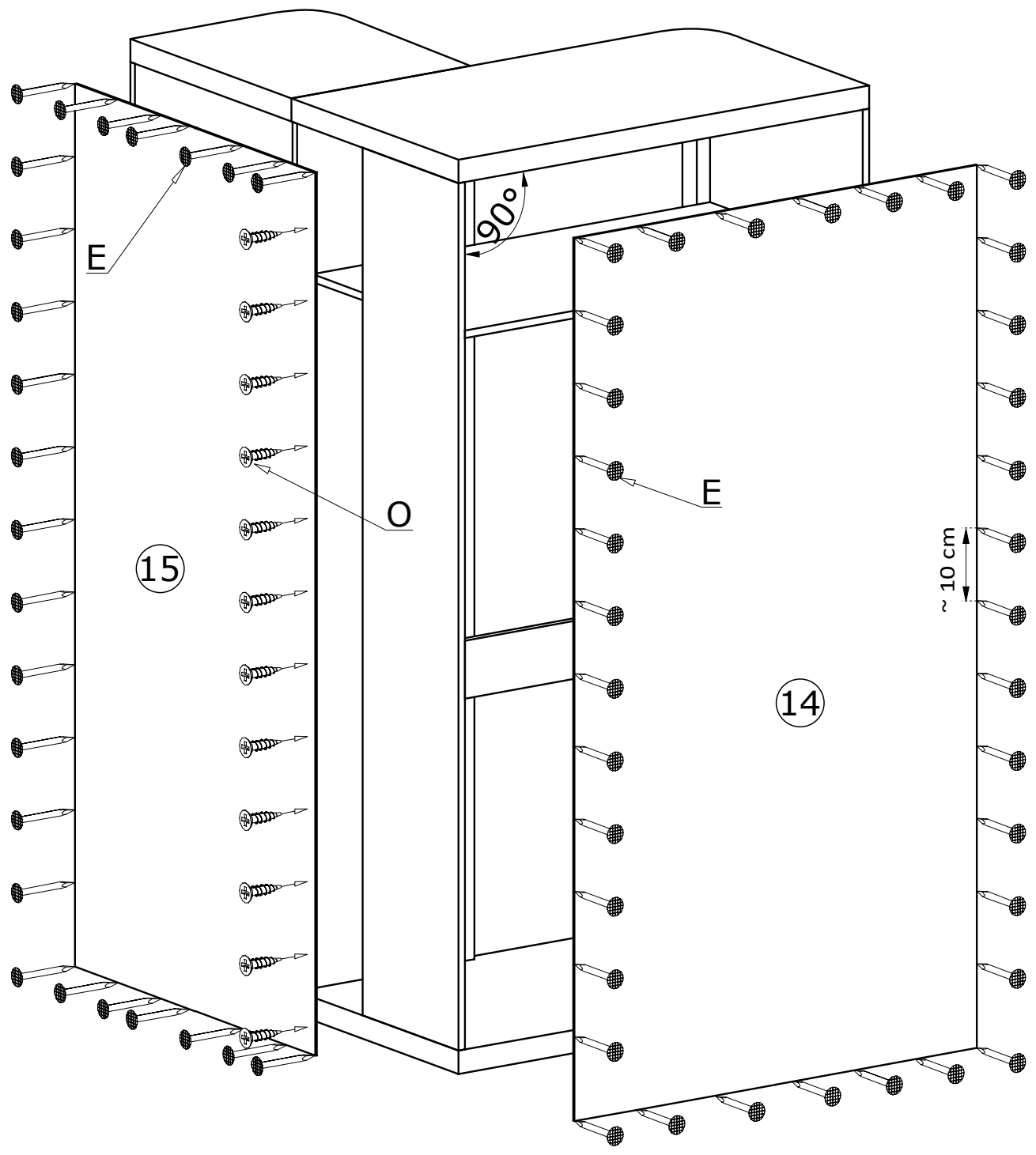

VI

